

Istruzioni di Montaggio

Assembly instruction

Instructions de montage

Montageanleitung

Instrucciones de montaje

Instruções de montagem

# LUXOR

## Angolo 2 ante scorrevoli

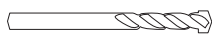
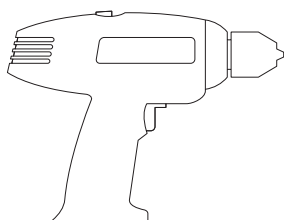
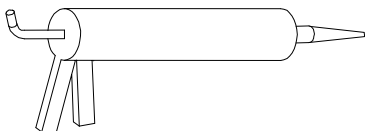
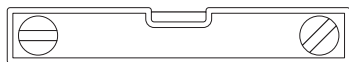

Ø 6

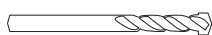

Ø 3  
Ø 2,5



Ø 4

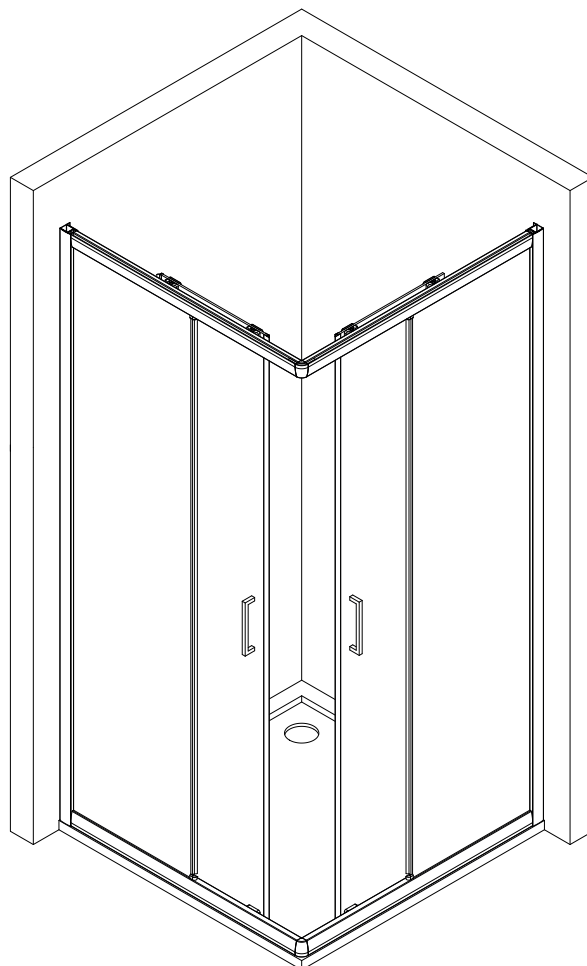

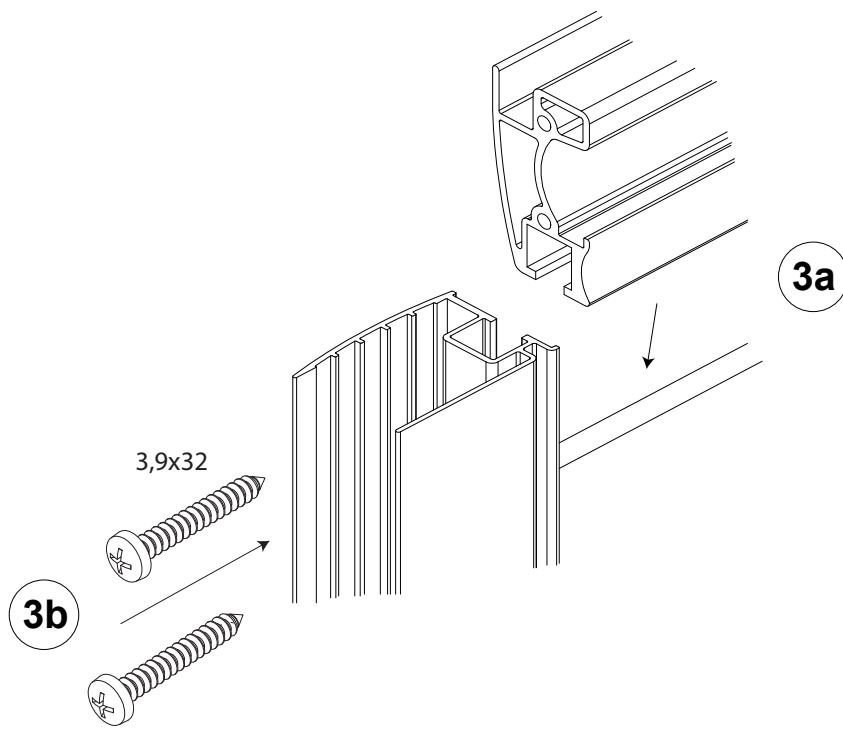
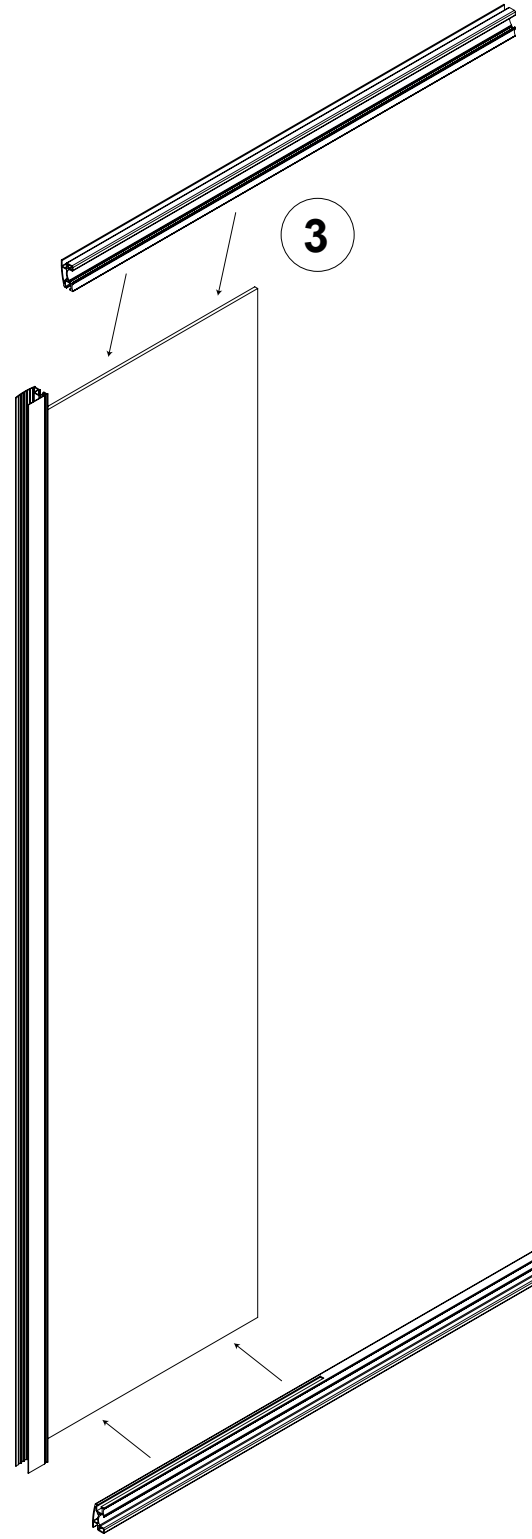
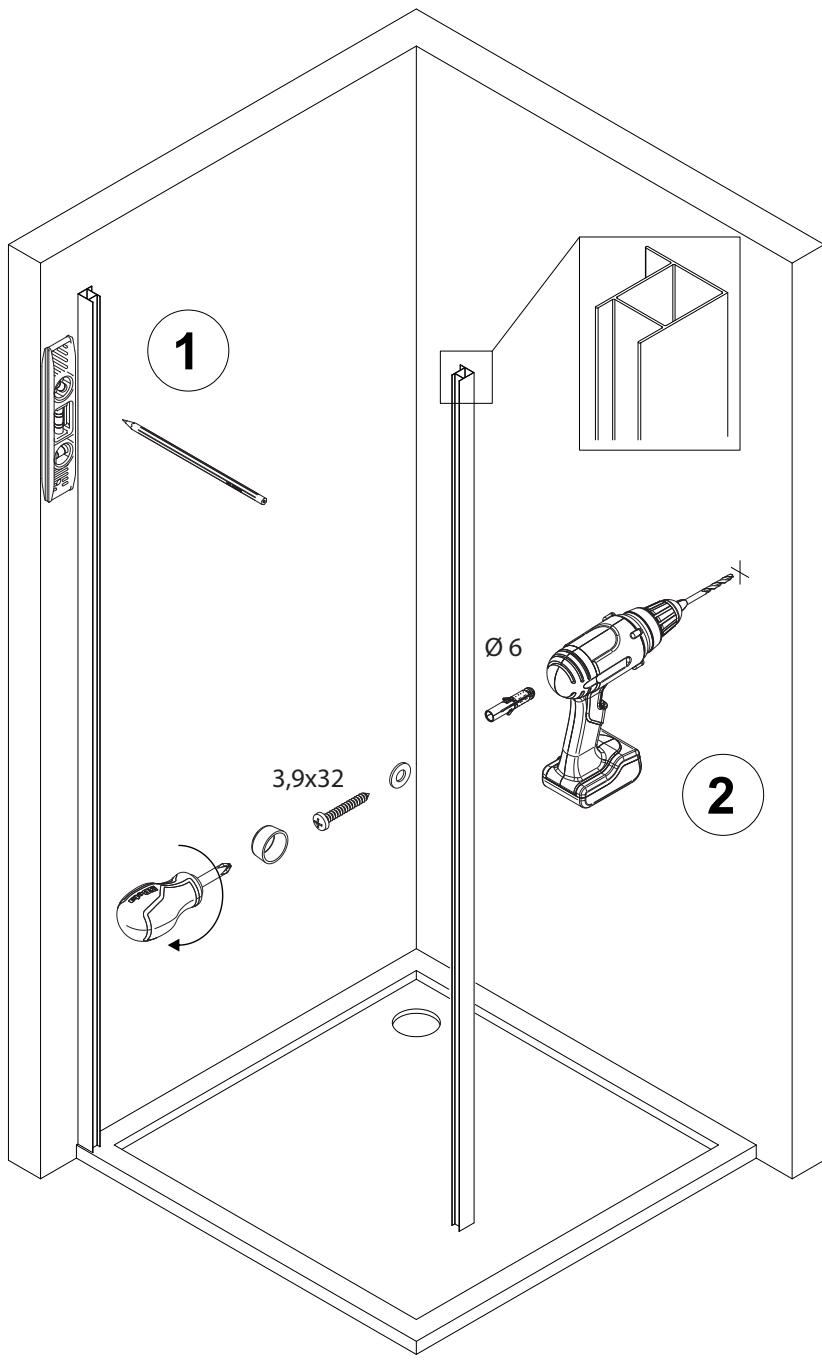

2,9 x 13

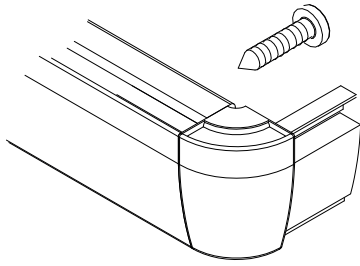

5

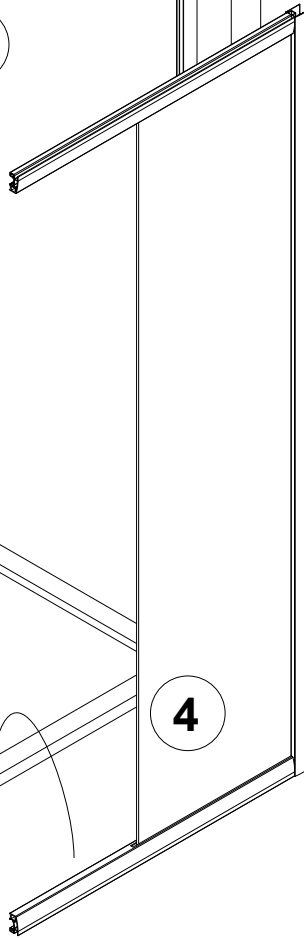

4

7

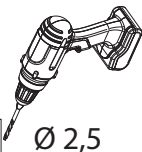

Ø 2,5

7



2,9 x 13

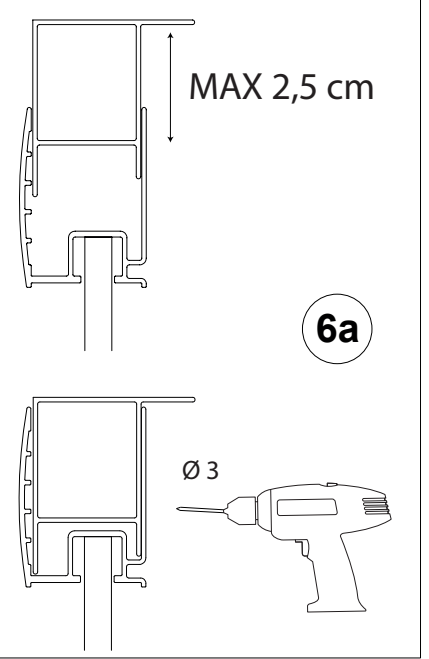

MAX 2,5 cm

6a

Ø 3

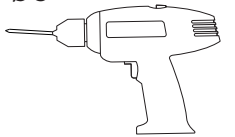

6

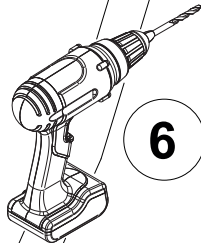

3,5x9,5

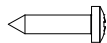

6b

